

Infrared Multi Analyzer IM series



10-wavelength, 4-constituent, High-speed/High-repeatability, Multi-interface, Easy to operate

IM series is an on-line multi analyzer utilizing the infrared absorption of measuring object. Converting capabilities are built into the compact designed detector unit for easy installation and operation. Maximum 99 calibration curves can be stored into the detector memory for numerous measurement applications. The detector can be used by itself or connected to a PC/plant control system, as both analog and digital outputs are provided.

A remote setting display unit, connectable up to 9 detector units, can be used to set various detector functions and also displays measured values.

■ FEATURES

- Up to 10 wavelength, measurable 4 constituents, moisture, film-thickness, organism, and coating-thickness in real time.
- Correspond with multi interface, RS-485 (MODBUS), Ethernet (LAN) (option)
- High-speed & High-repeatability (28ms).
- Multi-calculation function.
- Self-diagnostic function, easy maintenance.
- Conform to CE marking and IP-65.

■ CONFIGURATION

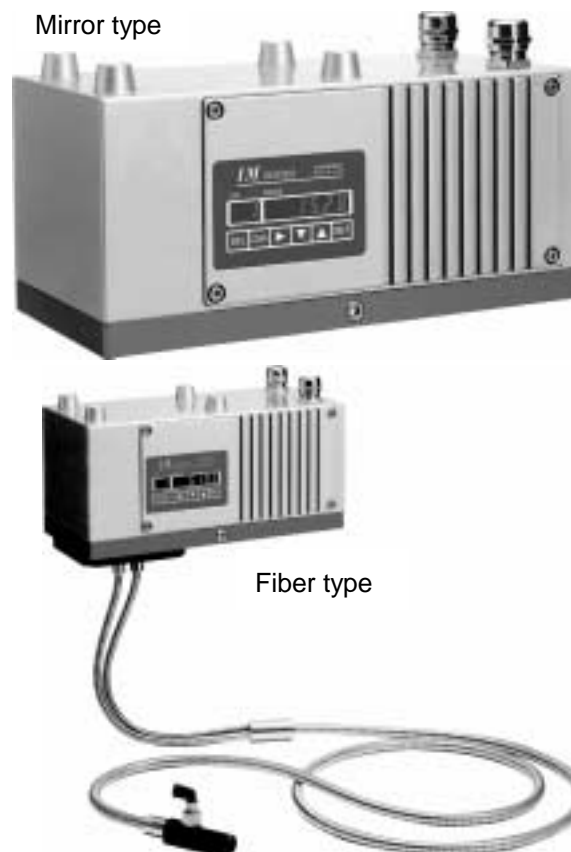
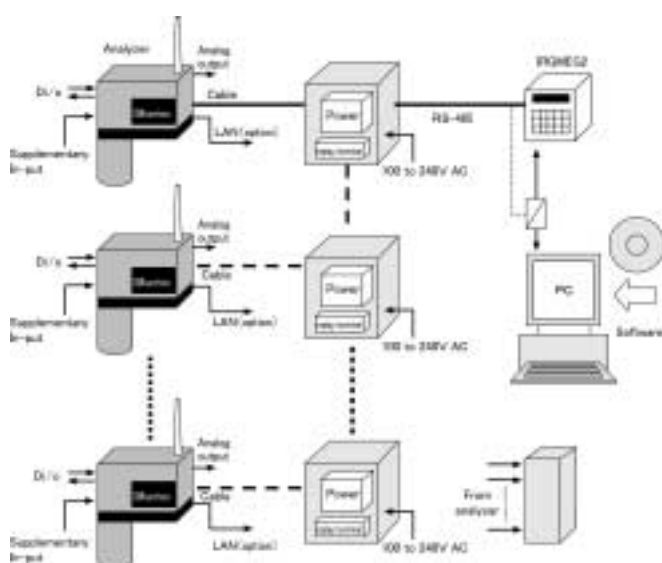

■ APPLICATION

- Measuring moisture of wood chip.
- Measuring the thickness of sheet or film.
- Measuring the organism, moisture and lipid of fodder.
- Measuring the organism, moisture and oil of potato chips.
- Measuring moisture of garbage (RDF moisture).
- Measuring the coating thickness on the painting sheet.
- Measuring moisture of powder.
- Measuring moisture in cleaning solution.
- Measuring moisture of clay.
- Measuring moisture of fiber.
- Measure & Control the coating thickness of Laminate-sheet production line.
- Measure & Control the painting thickness.

MODELS

Analyzer unit

IRMA

Type

- 1000series ... Moisture mirror type
 - 11 : Universal moisture
 - 12 : High moisture
 - 13 : Micro moisture
 - 2000series ... Moisture fiber type
 - 21 : Universal moisture
 - 22 : High moisture
 - 5000series ... Multi-component mirror type
 - 51 : Multi-component (NIR)
 - 52 : Multi-component (thin-film, Infrared)
 - 6000series ... Multi-component fiber type
 - 61 : Multi-component
 - 7000series ... Thickness, coating mirror type
 - 71 : Multi-component
 - 72 : Multi-component (thin-film, Infrared)
 - 78 : Micro moisture
 - 8000series ... Thickness, coating fiber type
 - 81 : Thickness, coating
- Number of measuring wavelength or component:
 00 : Other than 5,000 & 6,000 series
 : For 5,000 & 6,000 series
 : Number of measuring wavelength: 2 to 0 (10)
 : Number of measuring wavelength: 1 to 4
- Communications interface
 S: RS-485 (standard) *¹
 L: Ethernet (LAN)
- Special specification *²
 Blank: standard
 1: Small diameter type
 2: Rust prevention type
 3: Gain specifications
 4: P polarized light

*¹: RS-485 is not applicable when L is selected.

*²: Other special applications in the models are possible.

MODELS

Setting display unit

IRGMEG2

- Communications interface
 R: RS-232C (standard)
 A: RS-422A
 S: RS-485
- Special specification *²
 Blank: standard
 V: with CE marking



Setting display unit

MEASURING EXAMPLES

| Object | Range | Accu. | High moisture | |
|------------------------------------|---------|--------|----------------------------------|------------------|
| Universal type moisture (%) | | | Plaster | 5 to 15 >±0.7 |
| Glass / pottery / cement | | | Wet paper | 40 to 70 >±0.5 |
| Potter's clay | 0 to 12 | >±0.3 | Raw bread crumbs | 30 to 40 >±0.7 |
| Iron / metal | | | Clay | 0 to 30 >±0.8 |
| Coal | 0 to 15 | >±0.2 | Silex | 0 to 10 >±0.8 |
| Mix raw material | 0 to 10 | >±0.2 | Bicarbonate | 0 to 18 >±0.6 |
| Iron oxide | 0 to 10 | >±0.2 | Micro moisture | |
| Foods | | | ABS, PVC powder | 0 to 1 >±0.08 |
| Starch | 0 to 25 | >±0.2 | Granular ferrite | 0 to 0.5 >±0.03 |
| Bread-crumbs | 0 to 20 | >±0.2 | Thickness (μm) | |
| Soybean | 0 to 15 | >±0.2 | Polyethylene PE | 10 to 3000 >±0.2 |
| Milk powder | 0 to 5 | >±0.2 | Polypropylene PP | |
| Sugar / salt | 0 to 2 | >±0.05 | Polyester PET | |
| Flavoring | 0 to 10 | >±0.2 | Vinyl chloride PVC | |
| Tea | 0 to 15 | >±0.2 | PVA | |
| Chemicals | | | EVA | |
| Catalyst | 0 to 10 | >±0.2 | Polystyrene PS | |
| Medium | 0 to 20 | >±0.2 | Polycarbonate | |
| Detergent | 0 to 15 | >±0.2 | Nylon PA | |
| Ink | 0 to 5 | >±0.2 | Polyimide PI | |
| Fertilizer | 0 to 5 | >±0.2 | TAC film | >±0.2 |
| Rubber / fiber / etc. | | | Coating (g/m²) | |
| Vinylon fiber | 0 to 10 | >±0.2 | Coat-paper | 10 to 1000 >±0.2 |
| Acrylic fiber | 0 to 10 | >±0.2 | Tuck-paper, label | |
| Wood chip | 0 to 10 | >±0.2 | Adhesive WET/DRY | |
| Paper | 0 to 10 | >±0.1 | Resin on steel-board | |

PACKAGE SOFTWARE

Main Screen

Displays measured data, trend and alarm value.
 Displays 4 constituents on one screen.
 Save data into specified folder, enable to search or read out the data.

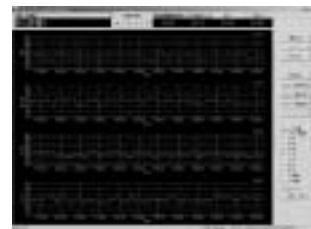

Create the Calibration Curve



Creates the calibration curve for new sample, and transmits the regression type data to detector.

Setting Interface

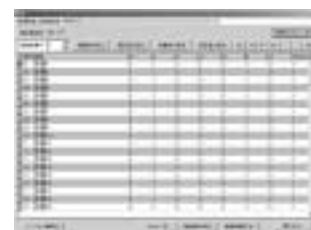

■ GENERAL SPECIFICATIONS

• MULTI ANALYZER DETECTOR UNIT

Measuring system: Infrared absorption type
Measuring wavelength: Up to 10 wavelengths
Measuring scope: Up to 4 constituents
Source of light: Tungsten lamp
Measuring distance and measuring diameter:
 $\phi 30/200\text{mm}$ or $\phi 50/300\text{mm}$

Output signal:
 1) Analog signal: 4 to 20mADC; $\pm 0.2\%$ of full scale
 (Load resistance: less than 500 Ω)
 2) Communications signal: RS-485 MODBUS (STD)
 3) Ethernet (LAN)

Output renewal cycle: 28ms

Display & setting: Show the measurement data and setting value.
 Various parameters are settable by key.

Computing function: Ratio calculation for 2-color or 3-color, and multiple regression calculation

Calibration curve number: up to 99 curves
Calibration curve: Linear, quadratic, cubic and multiple regression line
 Calibration curve correction: Linear & quadratic

Smoothing: 0 to 99 seconds, optional setting
Calibration: By checking plate
Setting detector number: Use multi-head then set the detector number by key
Setting channel number: Set calibration curve number by key.

Self-diagnostic function: Display and output by communication and contact signal.

Input correction: Corrects the measured data by external 4 to 20mA DC (1 input).
 (sample temperature correction, etc.)

External Di/o: Di(contact input), selectable from preset, data-hold, real/ smooth functions.
 Do(contact output), selectable from self-diagnostic function (1b) or upper/lower limit alarm (1a).

Working temperature range:

0 to 50 °C (air cooling is necessary for higher than 45°C)

Power supply: 24V DC

Power consumption: Approx. 30VA

Connection: Terminals connection

Casing: Aluminum casing,
 drip-proof structure (conforming to IEC529, IP65)

Weight: Approx. 4.3kg

Mounting: Suspension the analyzer uses 4-M8 bolts.

CE-marking specifications:

EN61326+A

SPECIAL SPECIFICATIONS

| Specification | Content |
|--------------------|---------------------------------------------|
| Small diameter | Mirror reflected type 30mm \square |
| Rust prevention | For inside printed-circuit board |
| Gain specification | Special sample * Judged by sample test |
| P polarized light | Thin-film sample * Judged by sample test |

• SETTING DISPLAY UNIT

Detector unit input:

RS-485, Connectable with max.9 detector units

Analog output:

1) Analog signal: 4 to 20mADC; 2 output*
 (Load resistance: less than 500 Ω)

* In the case of multi-head, output from No.1 and No.2 connected detectors.

2) Communications signal: specified from RS-232C, RS-422A or RS-485.

Output scaling: By numeric key

Output renewal cycle:

Communications output: 28ms \times detector number

Display: 1) Measured data, LED 5-digit
 2) Head No., CH. No., parameter.

Setting detector number:

Set detector head No.1 to No.9 by key

Setting channel number:

Set calibration curve number by key.

Smoothing time: T=0.1 to 99.9 seconds

Calibration: After output checking plate inserted, calibrate by key or external contact.

Hold/preset: Hold or preset the display and output by key or external contact.

Calibration curve correction: Corrects the calibration curve online or linear, quadratic correction.

External setting: Head number, CH. No., Calibration Hold, Preset.

Alarm function: Contact 1 output (HCL) outside of setting-range.

Self-diagnostic: Contact 1 output

Power supply: 100 to 240V AC 50/60Hz

Power consumption: max. 15VA

Working ambient temperature: 0 to 50°C

Casing: ABS resin (IP65)

Mounting: Panel-mount type

Weight: Approx. 0.6kg

CE-MARKING SPECIFICATIONS

Analog output: 4 to 20mADC; 1 output
 (Load resistance: less than 500 Ω)

Power supply: 24V DC (within $\pm 10\%$)

Power consumption: About 10VA

• FIBER UNIT

Measuring distance and measuring diameter:

with lens: ... $\phi 25/25\text{mm}$ to $\phi 40/100\text{mm}$

without lens: ... $\phi 20/15\text{mm}$ to $\phi 50/50\text{mm}$

Fiber length:

Standard 1.5m, Max.5m (Reflection type fiber)

Standard 2m, Max.10m (Transmission type fiber)

Fiber protection: Stainless steel snake tube

Minimum bending radius: R100mm

Working temperature range: 0 to 150°C

Purge air flow:

with lens: ...non air purge

without lens: ...5 to 20NL/min

Accessory: Vertical mounting holder,
 Flange holder

■ DIMENSION of SENSORS / ACCESSORIES

● Analyzer

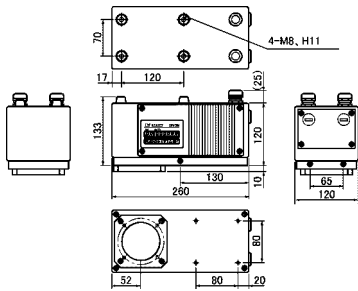

● Setting display unit

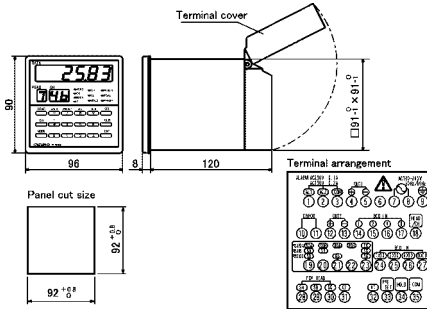

● Power supply unit

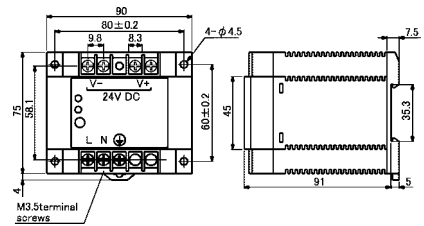

● Air purge hood

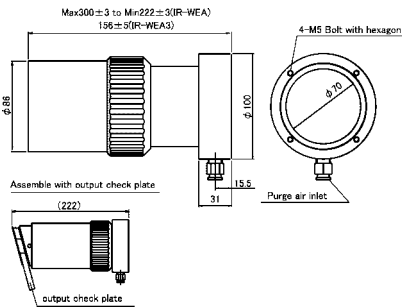

● Output checking plate

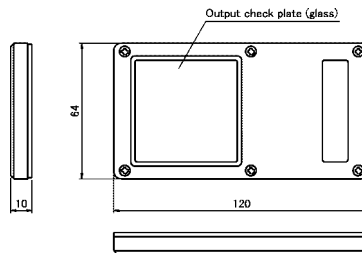

● Connecting cable

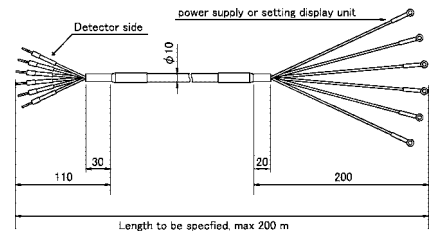

● Reflection type fiber (without lens)

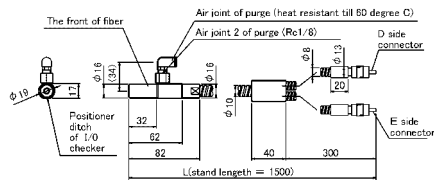

● Reflection type fiber (with lens)

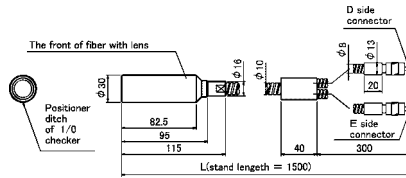

● Transmission type

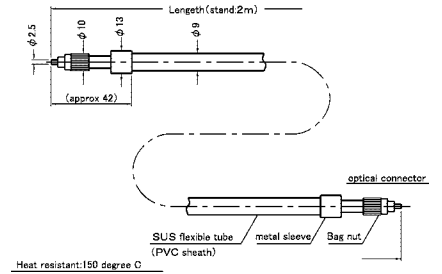

● Output checking plate for reflection type fiber

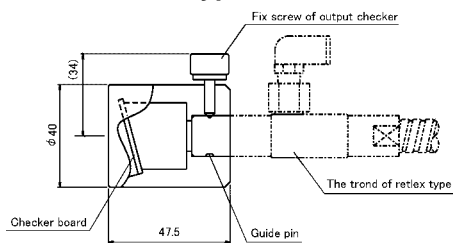

● Cell for liquid

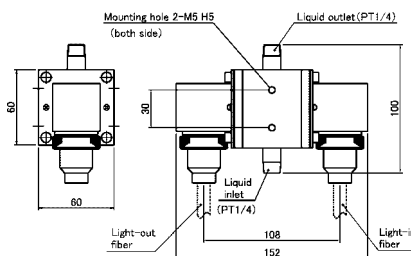

● Air-cooling box

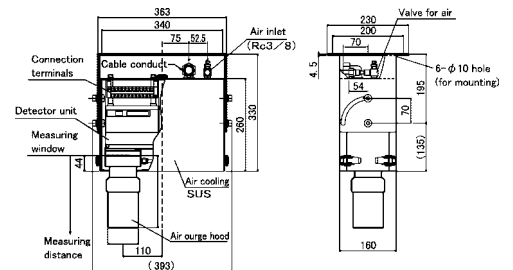

Specifications subject to change without notice. Printed in Japan (I) 2004. 6 Recycled Paper

CHINO CORPORATION

32-8, KUMANO-CHO, ITABASHI-KU, TOKYO 173-8632

PHONE: +81-3-3956-2171

FAX: +81-3-3956-0915

E-mail: inter@chino.co.jp

Website: http://www.chino.co.jp