

LCD Miniature Timer

DIN Size W48×H24mm, LCD Miniature Elapsed Time indicator

■ Features

- Compact size (DIN size W48×H24mm)
- Internal lithium battery
- Screw terminal connections
- LCD display
- Micro computer built-in

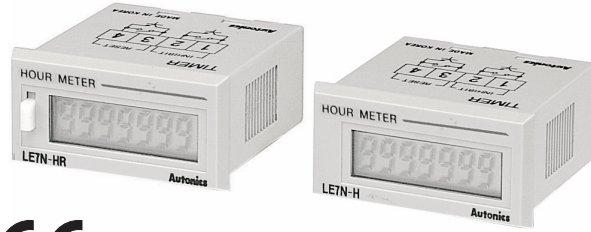

⚠ Please read "Caution for your safety" in operation manual before using.



■ Ordering information

L E 7 N - H F R

R	Front Reset switch No front Reset switch
F	Free voltage input No-voltage input
H	hour
M	min
S	sec
N	DIN Size W48×H24mm
7	9999999(Digit)
E	TIMER
L	LCD Display

※When selecting a model, please refer specifications.

■ Specifications

Item	No-voltage input type				Universal voltage input type			
	LE7N-S	LE7N-M	LE7N-H	LE7N-HR	LE7N-SF	LE7N-MF	LE7N-HF	LE7N-HFR
Model								
Digit	7digit							
Operation method	Up mode only							
Power supply	Not required (Battery built-in)							
Display method	LCD Zero Blanking method (Display size : H7mm × W3mm)							
Time range	0.0s~ 99h59m59.9s	0.0m~ 9999h59.9m	0.0h ~ 999999.9h	0.0h~ 999999.9h	0.0s~ 99h59m59.9s	0.0m~ 9999h59.9m	0.0h ~ 999999.9h	0.0h~ 999999.9h
Reset	Manual(Front)	None		Have	None		Have	
	External(Terminal)	Have						
Start input	●No-voltage input · Impedance at short-circuit:Max. 10kΩ (ON) · Impedance at open:Min. 500kΩ (OFF)				●Voltage input ☞ ON voltage:24-240VAC, 6-240VDC OFF voltage:0-1.5VAC, 0-2VDC			
Reset input								
Battery life cycle	Approx. 7 years at 25℃							
Insulation resistance	100MΩ (at 500VDC)							
Dielectric strength	1000VAC 50/60Hz for 1 minute							
Vibration	Mechanical	0.75mm amplitude at frequency of 10 ~ 55Hz in each of X, Y, Z directions for 1 hour						
	Malfunction	0.3mm amplitude at frequency of 10 ~ 55Hz in each of X, Y, Z directions for 10 minutes						
Shock	Mechanical	300m/s ² (Approx. 30G) in X, Y, Z directions 3 times						
	Malfunction	100m/s ² (Approx. 10G) in X, Y, Z directions 3 times						
Ambient temperature	-10 ~ +55℃ (at non-freezing status)							
Storage temperature	-25 ~ +65℃ (at non-freezing status)							
Ambient humidity	35 ~ 85%RH							
Approval	CE							
Weight	Approx. 55g							

(A) Counter

(B) Timer

(C) Temp. controller

(D) Power controller

(E) Panel meter

(F) Tacho/Speed/Pulse meter

(G) Display unit

(H) Sensor controller

(I) Proximity sensor

(J) Photo electric sensor

(K) Pressure sensor

(L) Rotary encoder

(M) 5-Phase stepping motor & Driver & Controller

LE7N Series

Specifications

Input	Model	Time range	Reset switch	Power supply
No-voltage input	LE7N-S	99h59m59.9s	None	Not required (3VDC Battery built-in)
	LE7N-M	9999h59.9m		
	LE7N-H	999999.9h		
	LE7N-HR	999999.9h	Have	
Universal voltage input	LE7N-SF	99h59m59.9s	None	
	LE7N-MF	9999h59.9m		
	LE7N-HF	999999.9h		
	LE7N-HFR	999999.9h	Have	

Dimensions

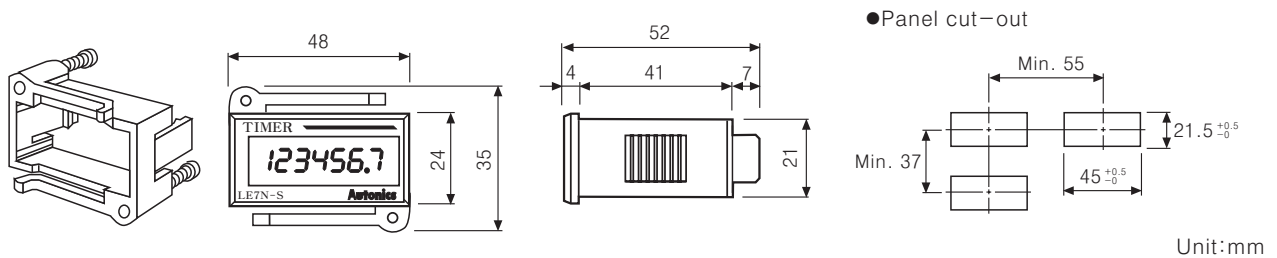

Connections

●No-voltage input

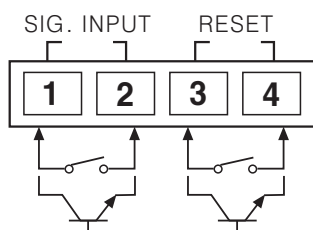

※Please use reliable contact enough to flow 10 μ A current.

※No. 2 and No.4 have been connected inside.

●Universal voltage input

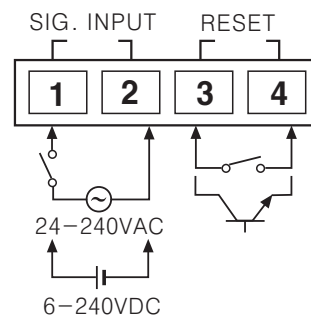

※Power terminal (No. 1, 2) and Reset terminal (No. 3, 4) are isolated.

Input(Start) and Inhibit

○No-voltage input type

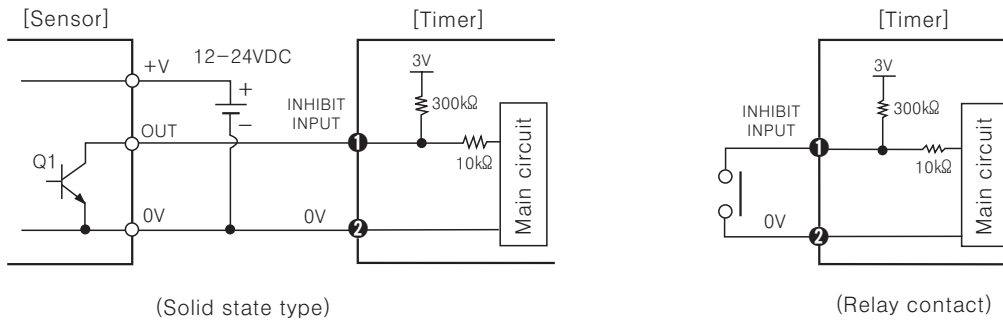

●Operation

- ① Q1 or relay contact is ON, the time progresses.
- ② Q1 or relay contact is OFF, the time is on inhibit states. When turn on the switch again, the time progresses again.
- ③ When the time reaches to Full scales, it will return to zero then progress again.

●Caution for using

- ※ Please use NPN open collector output type sensor.
- ※ Please supply the power for sensor from external.
- ※ Beware not to supply the power into INPUT terminal. (No. ①, ②)
- ※ Please use reliable contacts enough to flow 10μA current.

○Universal voltage input type

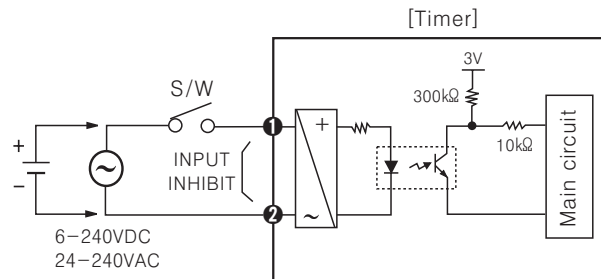

●Operation

- ① S/W ON, time progresses.
- ② S/W OFF, the time is on inhibit states. When turn on the switch again, the time progresses again.
- ③ When the time reached to Full scales, it will return to zero when progressing again.

●Caution for using

Do not use the AC type of the proximity sensors as a switch without any load like below.
Please put some load to prevent malfunction occurring because of leakage current of the proximity sensor.

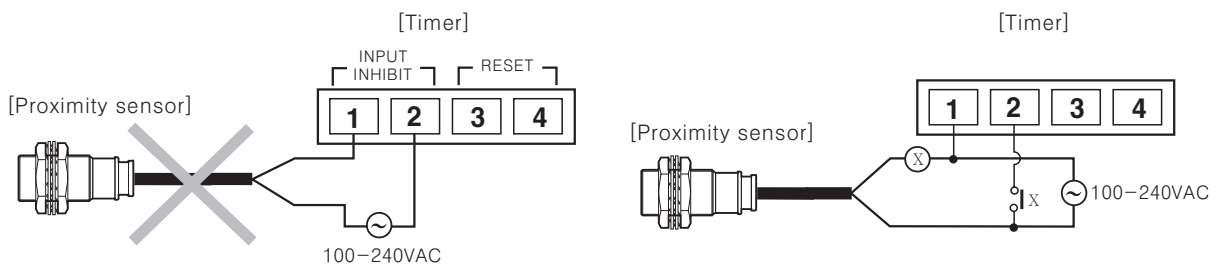

(A)
Counter

(B)
Timer

(C)
Temp.
controller

(D)
Power
controller

(E)
Panel
meter

(F)
Tacho/
Speed/
Pulse
meter

(G)
Display
unit

(H)
Sensor
controller

(I)
Proximity
sensor

(J)
Photo
electric
sensor

(K)
Pressure
sensor

(L)
Rotary
encoder

(M)
5-Phase
stepping
motor &
Driver &
Controller

LE7N Series

Reset

● Operation

When input transistor (Q1) or relay contact is ON, it will be RESET.

● No voltage input type

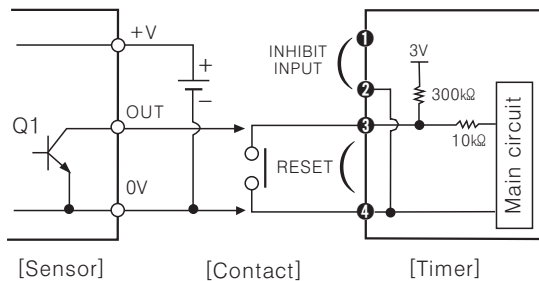

※ ②, ④ are GND terminals and connected inside.

● Universal voltage input type

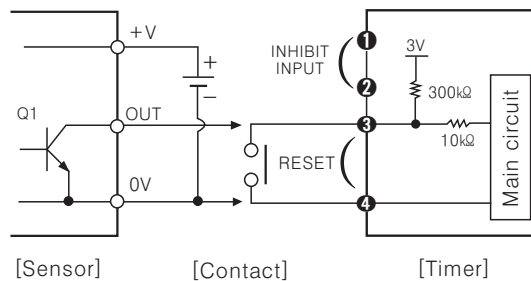

※ Between not to supply the voltage in No. ③, ④ RESET terminal.

※ Input terminal (No. ①, ②) and RESET terminal (No. ③, ④) are insulated inside.

※ When RESET required with relay contact. Please use a contacts that can function reliably at 10μA max.

※ Please supply the power for sensor from external.

● How to use front reset switch

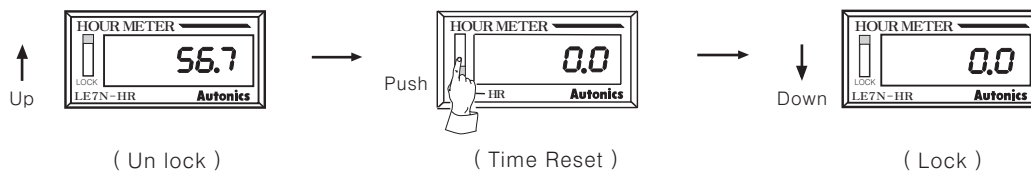

※ Model : LE7N-HR, LE7N-HFR

※ Lock switch up for reset.