



Data sheet

## Pressure switch, type CS

### Description



Pressure switch type CS is part of the Danfoss pressure control range. All CS pressure switches have a built-in pressure-operated, three-pole or one-pole switch, the contact position of which depends on

- the pressure in the connector
- the range setting.

The pressure switches are fitted with a manual switch that will lock the contact system in the open position independently of the pressure in the system.

#### CS product range

- Standard CS pressure switches
  - pressure connection: G ½ or G ¼
- CS pressure switches with special pressure connection made of polyacetal
  - suitable in drinking water applications
  - pressure connection: G ½

#### Stop pressure range

Pressure switches are supplied in the following three versions:

- low-pressure, 2-6 bar
- intermediate pressure, 4-12 bar
- high-pressure, 7-20 bar.

#### Contact system

Three-pole (TPST), contact system which opens on rising pressure. The contact system is touch-safe with open terminals, self-lifting terminal screws and star/slot screws.

#### Cable entry

The pressure switches have threads for two PG 16 screwed cable entries.

#### Screwed cable entries

Screwed cable entries are supplied with single pack CS pressure switches. Screwed cable entries for CS in industrial packs must be ordered separately under code no. 031E029366 containing seals and Pg 16 nuts.

#### Pressure relief valve

This valve relieves pressure on the compressor piston. It can be supplied as an accessory and must be ordered separately. The valve has an M10 x 1 external thread, union nut and cutting ring. The nut and cutting ring are both available in 6 mm and 1/4 inch sizes.

#### Manual switch

When the manual switch has been used to lock the contact system in its open position, the cover can be removed without the plant starting.

#### Enclosure

The enclosure is made of plastic (PA 6) and is obtainable in IP 43 or IP 55 versions to IEC 529. A knockout in the base of the enclosure can be removed to provide a drain hole for condensate.

### Application

The CS pressure switch is used for the automatic start and stop of

- air compressors
- pumps for pressure water systems (pressure storage tanks).

The CS with pressure relief valve is used in compressed air systems where pressure relief on the compressor piston before start is required.

### Approvals

EN 60 947-4,-5



Data sheet

Pressure switch, type CS

**Ordering**

  Preferred versions

Standard pressure switch type CS



Stop pressure $p_s$ bar	Min. differential $\Delta p$ bar	Max. differential $\Delta p$ bar	Max. test pressure $p_s$ bar	Grade of enclosure	Pressure connection	Code no.	Type
2 - 6	0.72 - 1.0	1.0 - 2.0	10	IP 43	G ¼	<b>031E020266</b>	1-pole
2 - 6	0.72 - 1.0	1.0 - 2.0	10	IP 43	G ¼	<b>031E020066</b>	
2 - 6	0.72 - 1.0	1.0 - 2.0	10	IP 55	G ¼	<b>031E020566</b>	3-pole
2 - 6	0.72 - 1.0	1.0 - 2.0	10	IP 43	G ½	<b>031E021066</b>	
2 - 6	0.72 - 1.0	1.0 - 2.0	10	IP 55	G ½	<b>031E021566</b>	
4 - 12	1 - 1.5	2.0 - 4.0	20	IP43	G ¼	<b>031E022066</b>	
4 - 12	1 - 1.5	2.0 - 4.0	20	IP 55	G ¼	<b>031E022566</b>	
4 - 12	1 - 1.5	2.0 - 4.0	20	IP 43	G ½	<b>031E023066</b>	
4 - 12	1 - 1.5	2.0 - 4.0	20	IP 55	G ½	<b>031E023566</b>	
7 - 20	2 - 3.5	3.5 - 7.0	32	IP 43	G ¼	<b>031E024066</b>	
7 - 20	2 - 3.5	3.5 - 7.0	32	IP 55	G ¼	<b>031E024566</b>	
7 - 20	2 - 3.5	3.5 - 7.0	32	IP 43	G ½	<b>031E025066</b>	
7 - 20	2 - 3.5	3.5 - 7.0	32	IP 55	G ½	<b>031E025566</b>	

Special versions with Polyacetal pressure connection - suitable for drinking water

Stop pressure $p_s$ bar	Min. differential $\Delta p$ bar	Max. differential $\Delta p$ bar	Max. test pressure $p_s$ bar	Grade of enclosure	Pressure connection	Code no.	Type
2 - 6	0.72 - 1.0	1.0 - 2.0	10	IP 43	G ½	<b>031E101066</b>	3-pole
4 - 12	1 - 1.5	2.0 - 4.0	20	IP 43	G ½	<b>031E101266</b>	
7 - 20	2 - 3.5	3.5 - 7.0	32	IP 43	G ½	<b>031E101466</b>	

Accessories and spare parts

Description	Code no.
Three pole contact system (TPST)	<b>031E029166</b>
Pressure relief valve, incl. fixing screw (for 6 mm pipe/hose)	<b>031E029866</b>
Pressure relief valve, incl. fixing screw (for 1/4 in. pipe/hose)	<b>031E029766</b>
Two Pg 16 screwed cable entries with gaskets (cable diam. 6.5 - 15 mm)	<b>031E029366</b>
Nipple with 7/16-20 UNF and M10 x 1 int.	<b>031E029666</b>

**Technical data**

Specifications

	Contact load a.c.	$I_n$		$U_n$	
		AC-3		DC-13/14	
		12 A	9 A	220 to 415 V	600 V
		2 A	220 V 3 contacts in series		
	Electrical life on rated load	100.000 operations			
	Mechanical life	1.000.000 operations			
	Ambient temperature	-20 to +70 °C			
	Temperature of medium	Water	0 to +70 °C		
		Air	-20 to +70 °C		
	Vibration-proof	0 - 1000 Hz ved 4 G			
	Resonance frequency	Direction A-B: 341 Hz Direction C-D: 332 Hz Direction E-F: 488 Hz			
	Diaphragm material	Hytrel			
	Pressure connector	Special: Polyacetal, G½ Others: Silumin, G¼ or G½			
	Pressure relief valve (capacity)	2000 cm³ from 10 → 1 bar pà 18.8 sec.			
Grade of enclosure to IEC 529	IP 43 or IP 55				

Properties according to EN 60947

Wire dimension solid/stranded	0.7 - 2.5 mm²
flexible, with/ without ferrules	0.75 - 2.5 mm²
flexible, with ferrules	0.5 - 1.5 mm²
Tightening torque	max. 1.2 NM
Rated impulse voltage	4 kV
Pollution degree	3
Short circuit protection, fuse	25 Amp
Insulation	600 V
IP-index	43/55



Data sheet

Pressure switch, type CS

**Design and function**

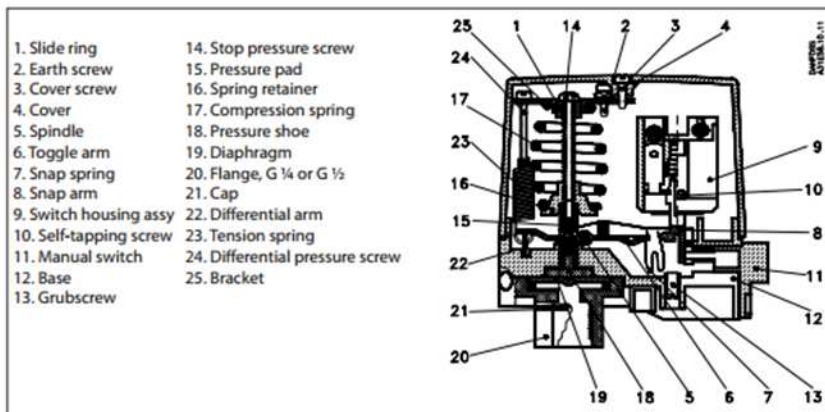

- |                        |                                 |
|------------------------|---------------------------------|
| 1. Slide ring          | 14. Stop pressure screw         |
| 2. Earth screw         | 15. Pressure pad                |
| 3. Cover screw         | 16. Spring retainer             |
| 4. Cover               | 17. Compression spring          |
| 5. Spindle             | 18. Pressure shoe               |
| 6. Toggle arm          | 19. Diaphragm                   |
| 7. Snap spring         | 20. Flange, G ¼ or G ½          |
| 8. Snap arm            | 21. Cap                         |
| 9. Switch housing assy | 22. Differential arm            |
| 10. Self-tapping screw | 23. Tension spring              |
| 11. Manual switch      | 24. Differential pressure screw |
| 12. Base               | 25. Bracket                     |
| 13. Grubscrew          |                                 |

The pressure switch is built up of the following main elements: connector, diaphragm, snap system, main spring, differential spring and a 3-pole or one-pole contact system. The stop pressure must be set on the main spring and the difference between start and stop pressures on the differential spring.

Pressure from the controlled system is led, via the connector, to the diaphragm. The diaphragm converts this pressure to a mechanical movement which is transferred by the snap system to the contact system. In this way, the contact system starts or stops a compressor/pump.

**Installation**

*Recommended orientation*

The pressure switches will operate regardless of their orientation. However, to meet the enclosure requirements of IP 43 and IP 55, they must be mounted vertically with the connection downwards. The CS pressure switches are self-supporting (on the connection).

*Fitting a pressure relief valve*

1. Remove the blanking plug
2. Fit the pressure relief valve
3. Fit the plastoform screw

*Fitting screwed cable entries*

The accessory bag contains two sets of metal gaskets each with different internal diameters. These will give a sufficient cord relief if used correctly with the cable diameter concerned.

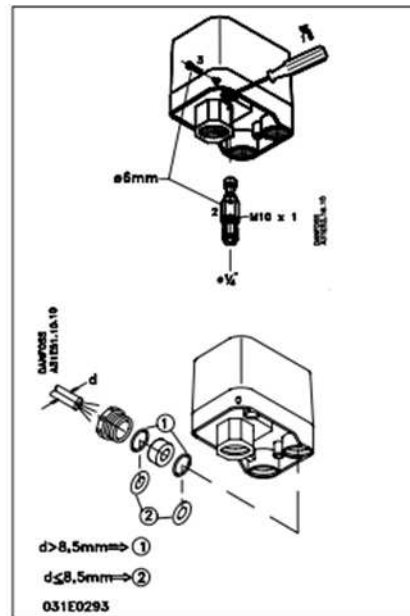

*Drain hole*

If because of large temperature variations there is a risk of condensate forming in the pressure switch, a screwdriver can be used to make a drain hole in the enclosure.

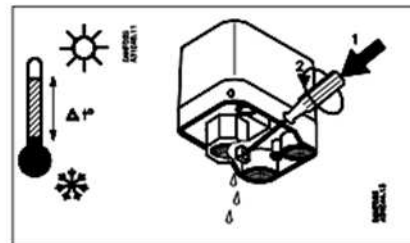



**Setting**

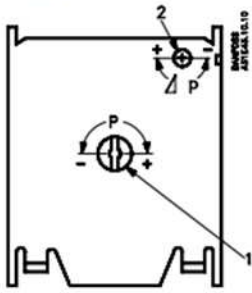

All standard versions of CS pressure switches are preset and supplied with springs under minimum compression.

1. Turn the stop pressure screw (1) the given number of times towards + (high stop pressure), see stop pressure graph.
2. Turn the differential screw (2) the given number of times towards + (max. differential), see differential pressure nomogram.
3. Start the plant and let it run until the required stop pressure is reached.
4. Turn the stop pressure screw (1) towards minus (lower stop pressure) until the plant stops.

5. Reduce the pressure to the required start pressure.
6. Turn the differential screw (2) towards minus (smaller differential) until the plant starts.
7. Check that the plant stops and starts at the required pressures.

**Note!**  
If the differential is set at a value greater than the stop pressure the plant cannot start. If this is the case, set the differential at a smaller value (towards minus).

**Example**

A compressor is to be regulated by a CS pressure switch. The start pressure is 3.5 bar, and the stop pressure 5 bar. The choice should be a CS with a range of 2 - 6 bar.

1. Turn the stop pressure screw (1) about 12 times. See cut-off pressure graphs.
  2. Turn the differential screw (2) about 4.5 times. See CS 2 -6 nomogram.
- Take a straight line from 5 bar stop pressure on the nomogram to the differential, 1.5 bar and read off the number of turns, i.e. 4.5.

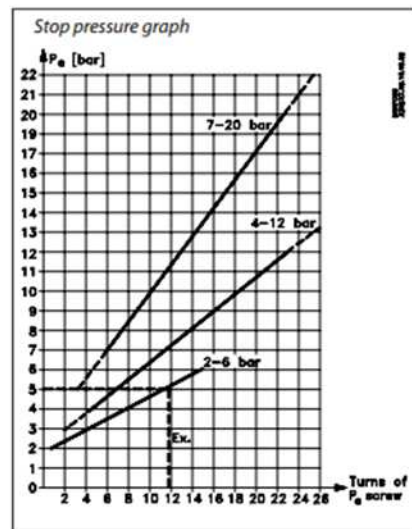

**Differential pressure nomograms**

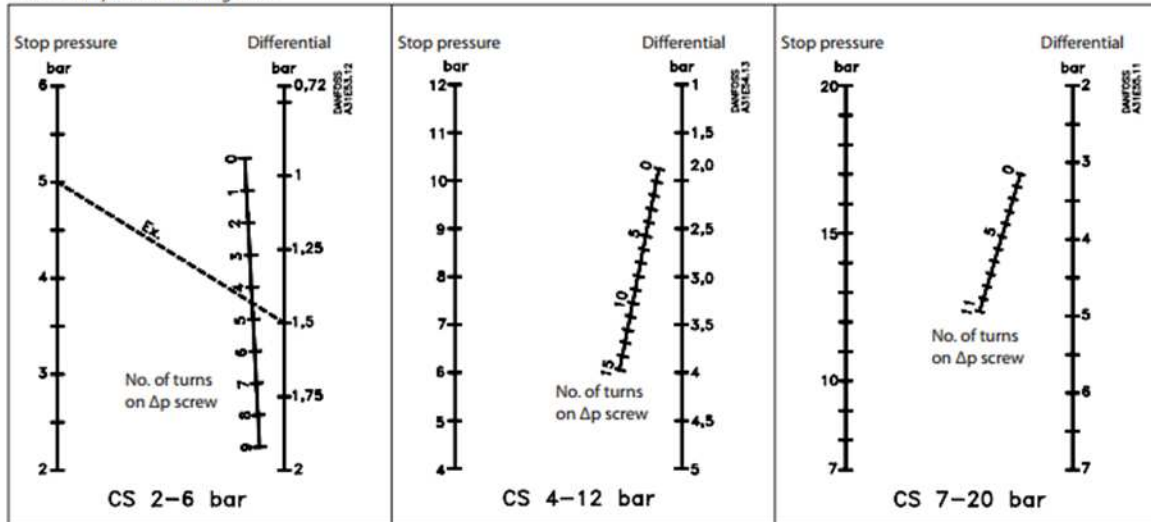

**Application examples**

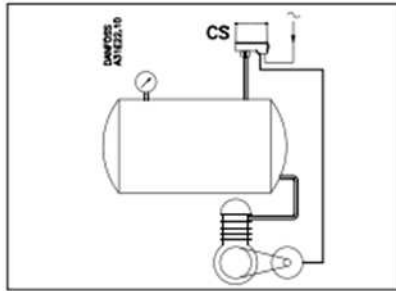

*Example 1*  
Control of an air compressor with a CS pressure switch.

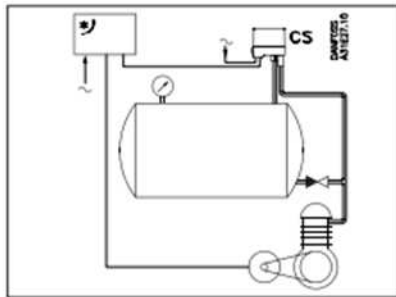

*Example 2*  
Control of a compressor with a CS pressure switch fitted with pressure relief valve. Note the check valve between pressure relief line and reservoir.

\* Motor starter or automatic start-delta switch

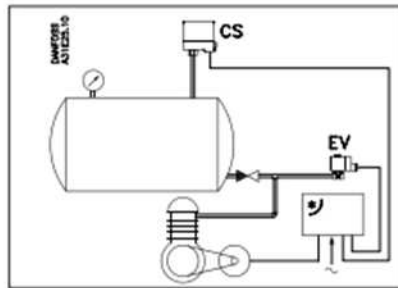

*Example 3*  
Control of an air compressor with a CS. An EV210B 3B solenoid valve is recommended where there is need for especially fast pressure relief.

\* Motor starter or automatic start-delta switch

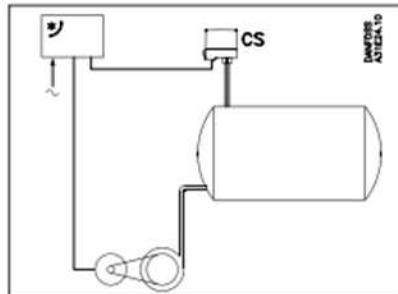

*Example 4*  
Control of a centrifugal pump with a CS, via an automatic star-delta switch, motor starter, or similar.

\* Motor starter or automatic start-delta switch

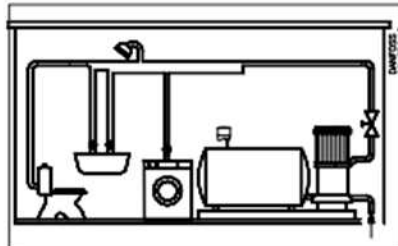

*Example 5*  
Pressure boosting system for domestic circuits. A type CS switch is used to start/stop the pump.



Data sheet

Pressure switch, type CS

Mains connection

3-pole

1-pole a.c.

1-pole d.c. load

Contact load		I <sub>a</sub>	U <sub>a</sub>
		AC-3	12 A
9 A	600 V		
DC-13/14	2 A	220 V (3 contacts in series)	

Dimensions

Weight approx. 0.5 kg

Danfoss can accept no responsibility for possible errors in catalogues, brochures and other printed material. Danfoss reserves the right to alter its products without notice. This also applies to products already on order provided that such alterations can be made without subsequent changes being necessary in specifications already agreed. All trademarks in this material are property of the respective companies. Danfoss and the Danfoss logotype are trademarks of Danfoss A/S. All rights reserved.