

# MVSC-220 series

SOLENOID VALVE

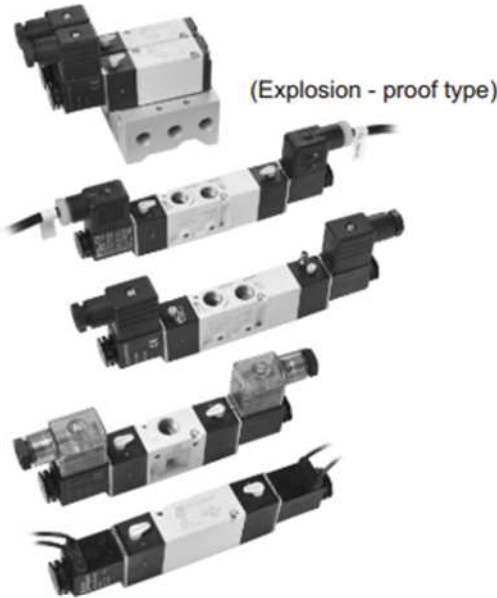

## Specification:

Model	MVSC-220-3E1,E2	MVSC-220-4E1,E2	MVSC-220-4E2C.P.R		
Bore No.	8A				
Port size	PT 1/4				
No. of port	3	5			
No. of position	2	2	3		
Medium	Air				
Operating pressure range	2~7 kgf/cm <sup>2</sup>		3~7 kgf/cm <sup>2</sup>		
Operating pressure (LP)	0~7 kgf/cm <sup>2</sup>				
External pilot pressure (LP)	2~7 kgf/cm <sup>2</sup>		3~7 kgf/cm <sup>2</sup>		
Proof pressure	10 kgf/cm <sup>2</sup>				
Effective orifice	18 mm <sup>2</sup>		16 mm <sup>2</sup>		
Response time	30 ms		40 ms		
Ambient temperature	- 5~ + 50°C (No freezing)				
Voltage	AC110V, 220V (50/60)Hz, DC24V				
Power consumption	AC=6/4.9VA, DC=2.5W				
Available voltage range	± 10%				
Insulation class	F class				
Weight	203 g	296 g	184 g	292 g	338 g

## Order example of valve:

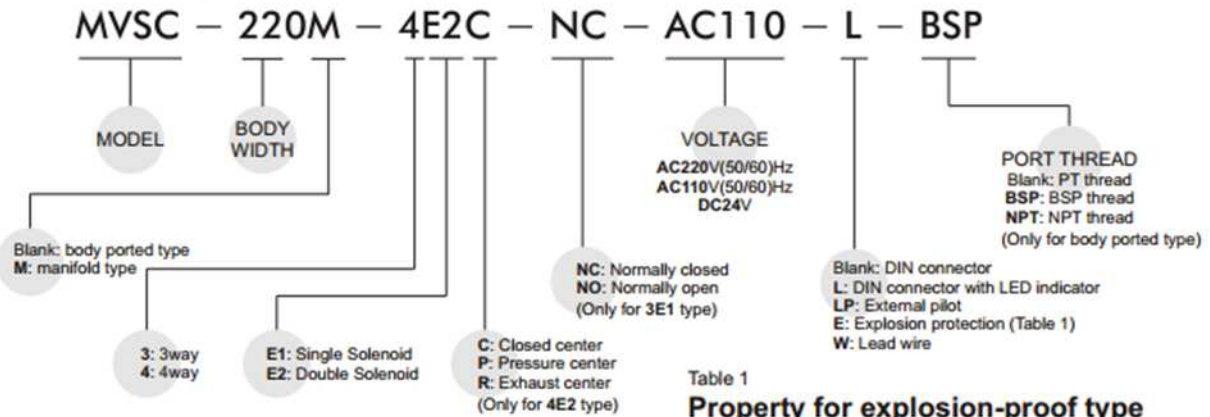

## Order example of manifold:

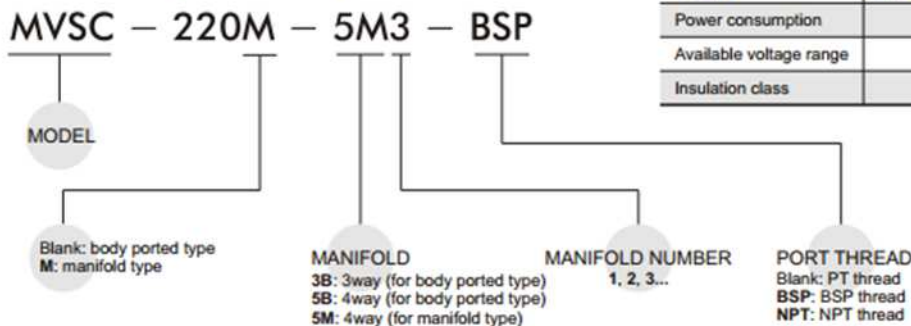

Table 1

## Property for explosion-proof type

Anti-explosion class	EEx m II T4
Voltage	AC110V, 220V, (50/60)Hz, DC24V.
Power consumption	AC=4.4VA DC=5W
Available voltage range	± 10%
Insulation class	F class

# MVSC-220 Dimensions

## SOLENOID VALVE



### MVSC-220-4E1

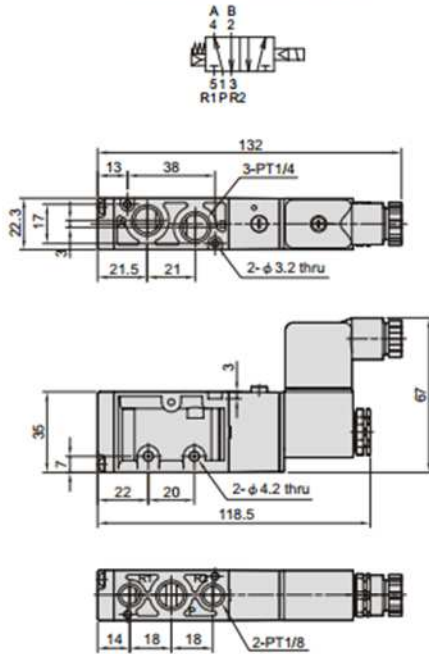

### MVSC-220-4E2

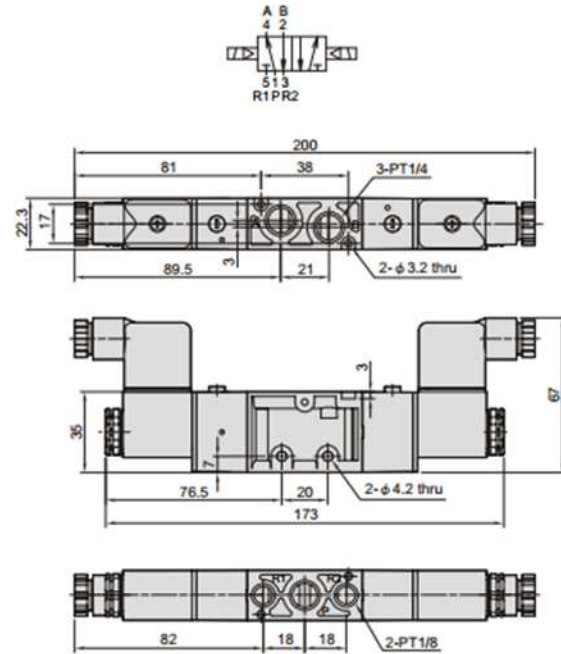

### MVSC-220-4E2C.PR

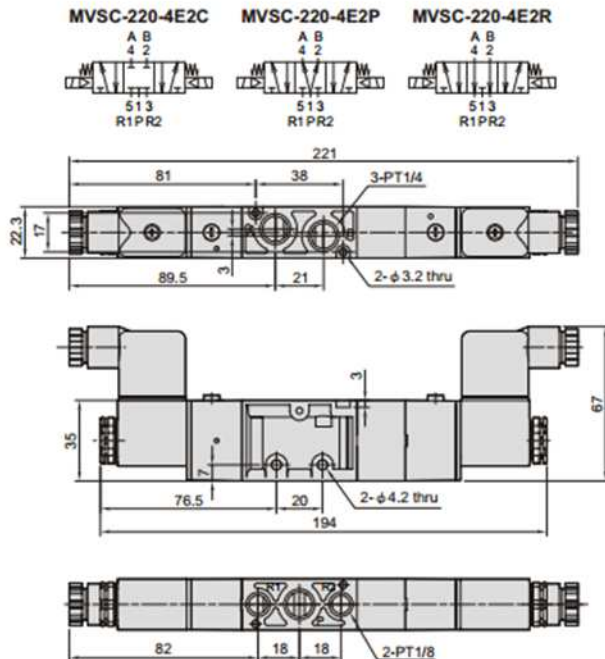

### LP

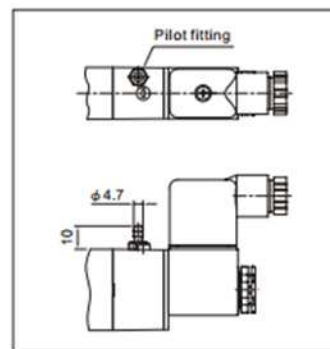

### Flow features:

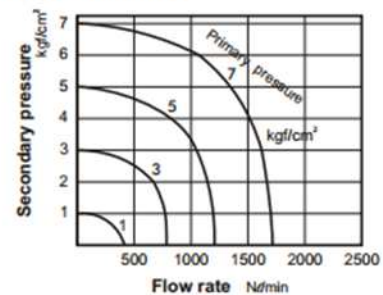

# MVSC-220 Dimensions / Manifold

SOLENOID VALVE



## MVSC-220-3E1-NC/NO

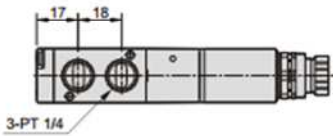
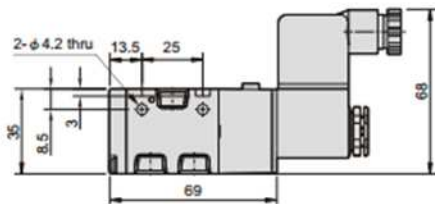
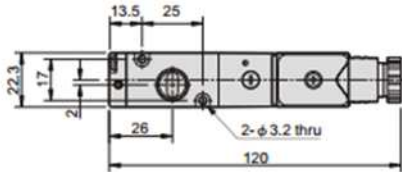
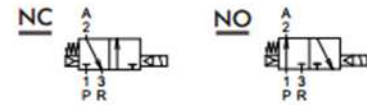

## MVSC-220-3E2

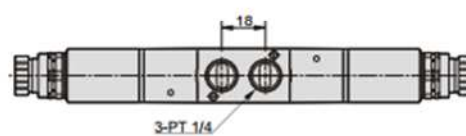
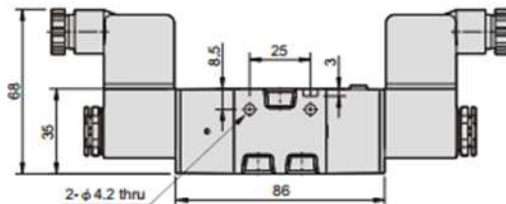
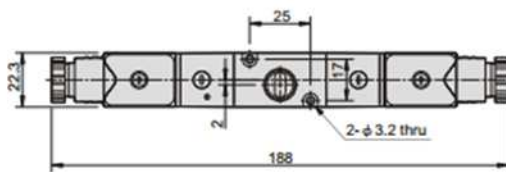
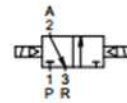

## Manifold of solenoid valve

### MVSC-220-3B\*

3way (for body ported type)

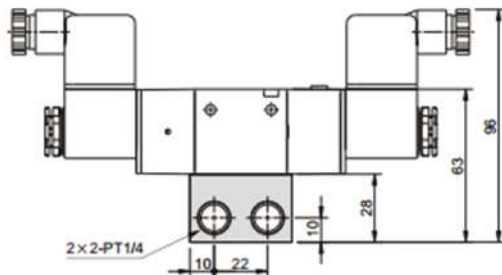
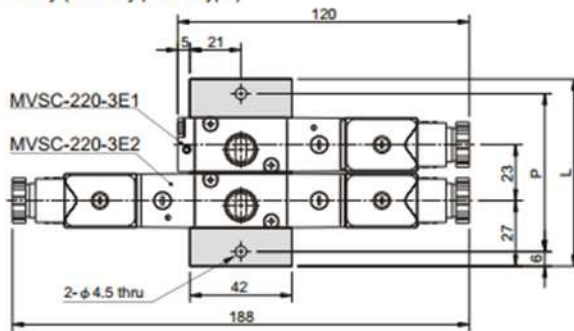

No. of stations	P	L
2	65	77
3	88	100
4	111	123
5	134	146
6	157	169
7	180	192
8	203	215
9	226	238
10	249	261

# MVSC-220 Manifold

## SOLENOID VALVE



### MVSC-220-5B\*

4way (for body ported type)

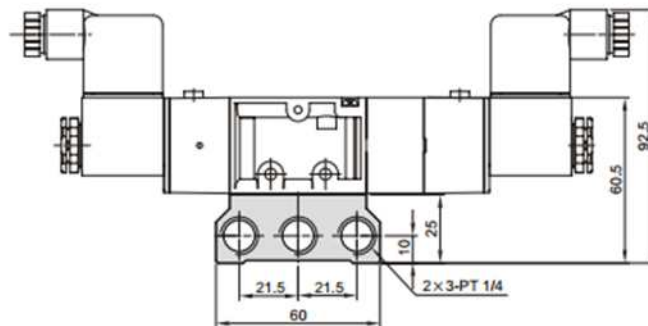
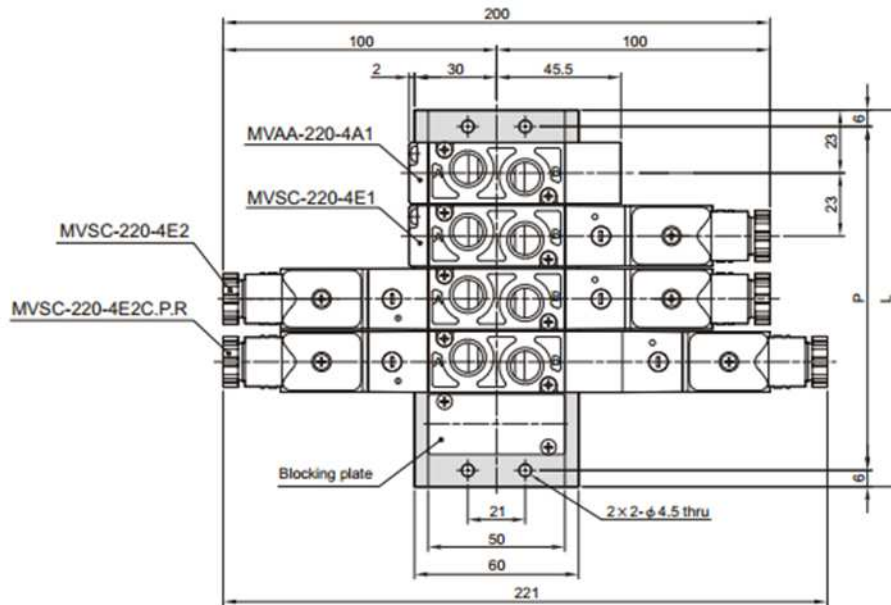

No. of stations	P	L
2	57	69
3	80	92
4	103	115
5	126	138
6	149	161
7	172	184
8	195	207
9	218	230
10	241	253

# MVSC-220 Manifold

## SOLENOID VALVE



### MVSC-220M-5M\*

4way (for manifold type)

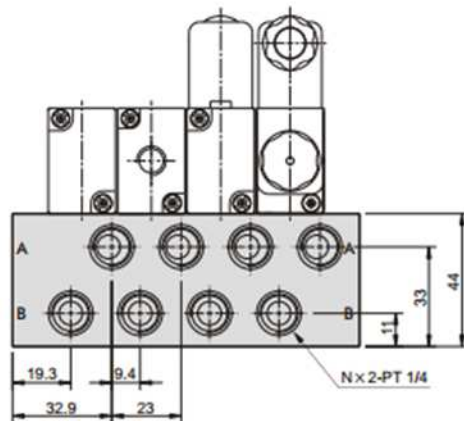
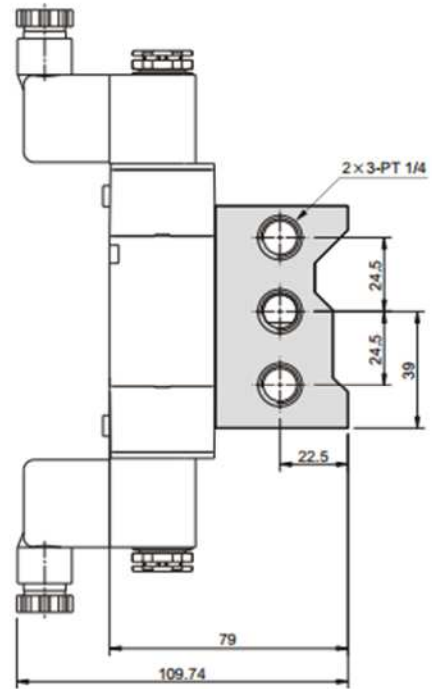
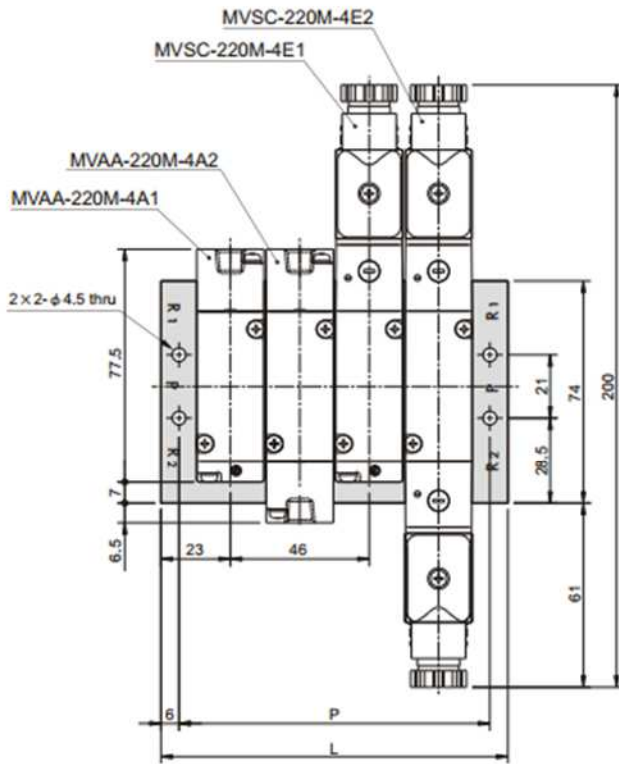

No. of stations (N)	P	L
2	57	69
3	80	92
4	103	115
5	126	138
6	149	161
7	172	184
8	195	207
9	218	230
10	241	253

