

MVSN-300 series

NAMUR SOLENOID VALVE

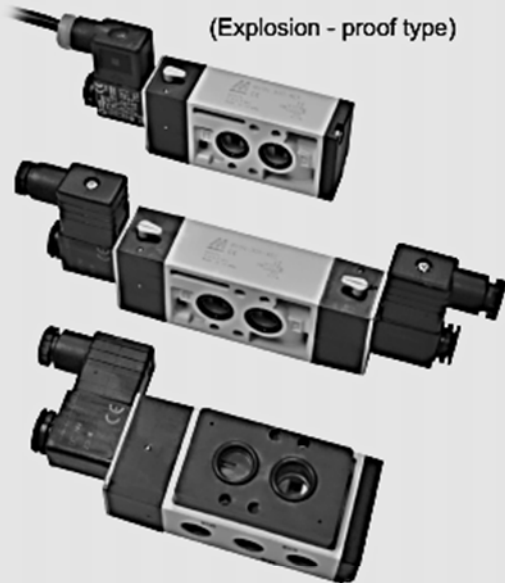

(Explosion - proof type)

Specification:

Model	4E1	4E2	4E2C.P.R.
Bore No.	8A		
Port size	G 1/4 (port A, R1, R2)		
No. of port	5		
No. of position	2	2	3
Medium	Air		
Operating pressure range	0.2~0.7 MPa		0.3~0.7 MPa
Proof pressure	1.05 MPa		
Effective orifice	35 mm ²		30 mm ²
Response time	50 ms		
Ambient temperature	-5~ +50°C (No freezing)		
Voltage	AC110V, 220V (50/60)Hz, DC24V		
Power consumption	AC=6/4.9VA, DC=2.5W		
Available voltage range	±10%		
Insulation class	F class		
Weight	422 g	507 g	764 g

※ Port thread Rc. NPT. are also available.

Order example of valve:

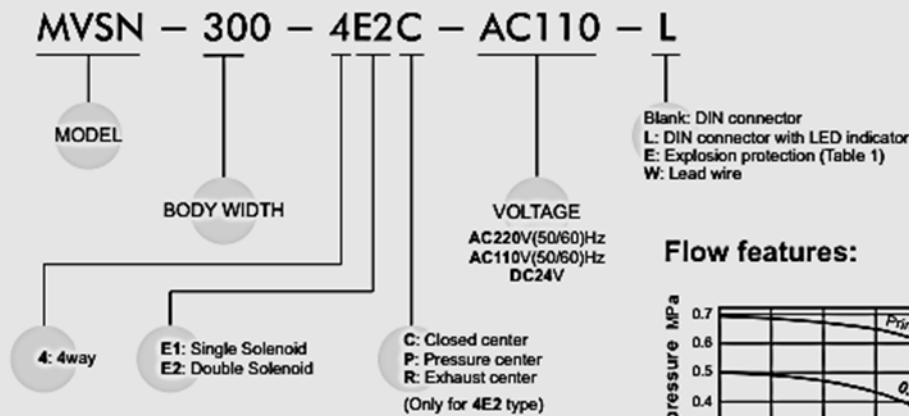

Order example of adapter:

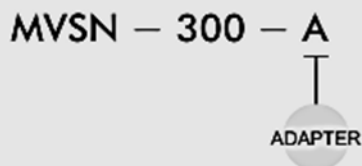

Flow features:

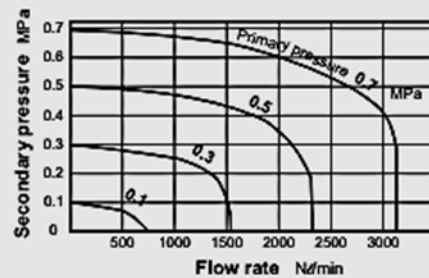

Table 1

Property for explosion-proof type

Anti-explosion class	EEx m II T4
Voltage	AC110V, 220V, (50/60)Hz, DC24V.
Power consumption	AC=4.4VA DC=5W
Available voltage range	±10%
Insulation class	F class

MVSN-300 Dimensions

NAMUR SOLENOID VALVE

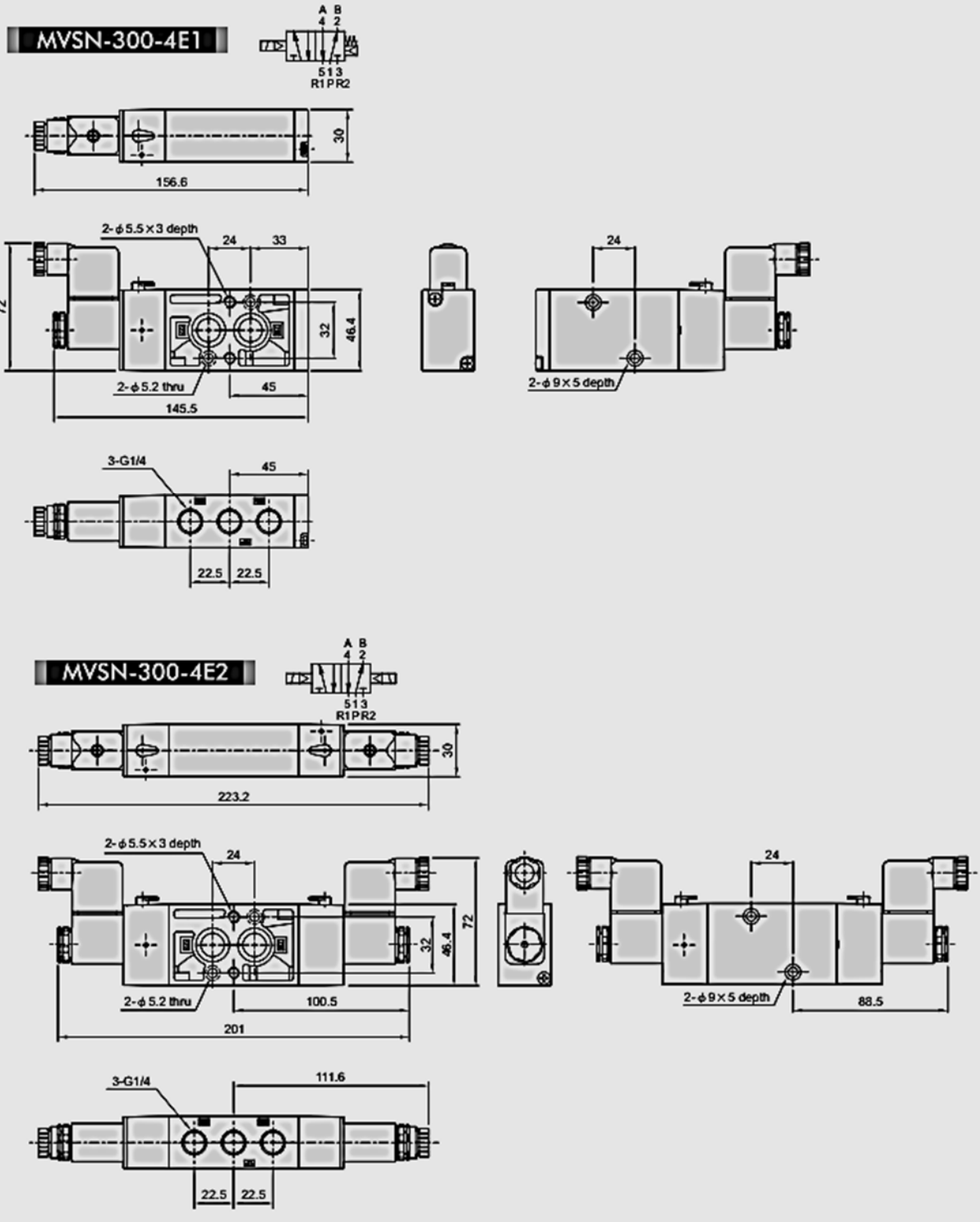

MVSN-300 Adapter

NAMUR SOLENOID VALVE



MVSN-300-4E2C.P.R

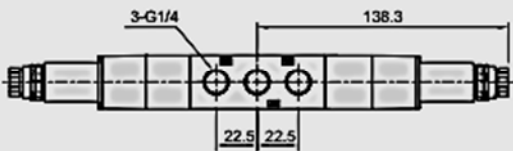
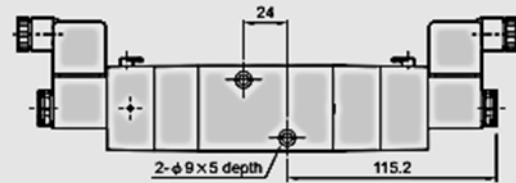
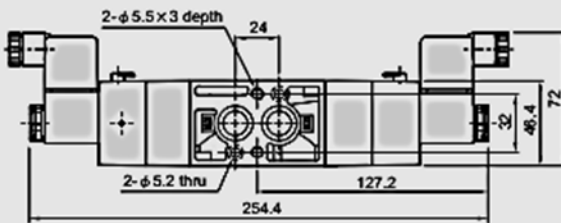
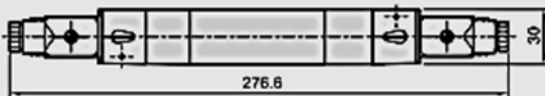
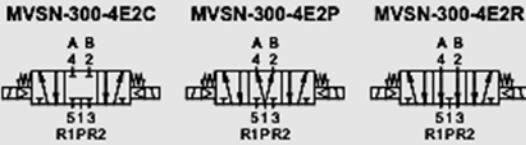

MVSN-300-A

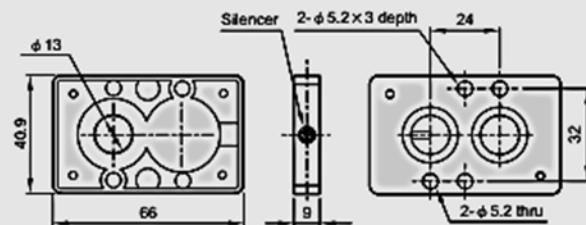
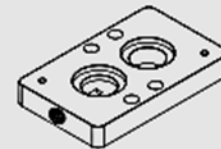
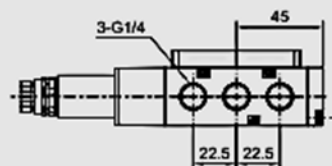
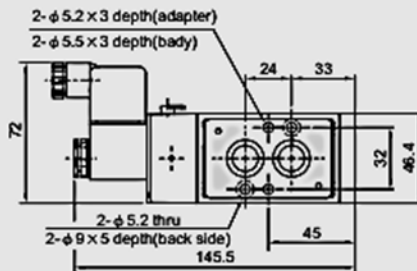
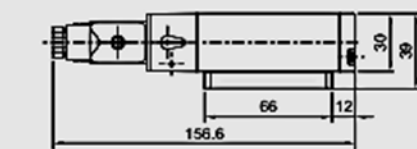

- Solenoid valve without plate : 5/2 single acting
- Solenoid valve with plate : 3/2 single acting
- Silencer on the OPPOSITE side of the solenoid : NC
- Silencer on the SAME side of the solenoid : NO

